

Linea Plus

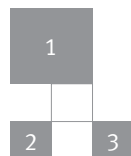



1. Optional towel rail, in the same colour as the casing (sandblast grey).
2. Linea Plus free-standing
3. Optional top valve



Linea Plus_Dimensions



LINW_Linea Plus Wall

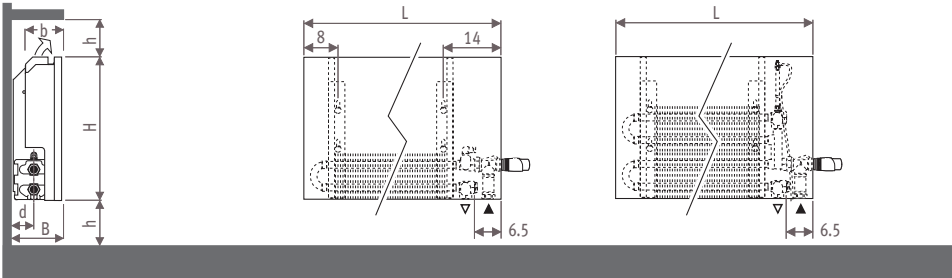

Dimensions in cm

type	b	B	d	BS	h/min*
10-11	8.8	11.8	5.3	13	10
15-16	13.8	16.8	7.8	18	12
20-21	18.8	21.8	10.3	23	15

* Smaller dimensions can decrease output.

LINF_Linea Plus Free-standing

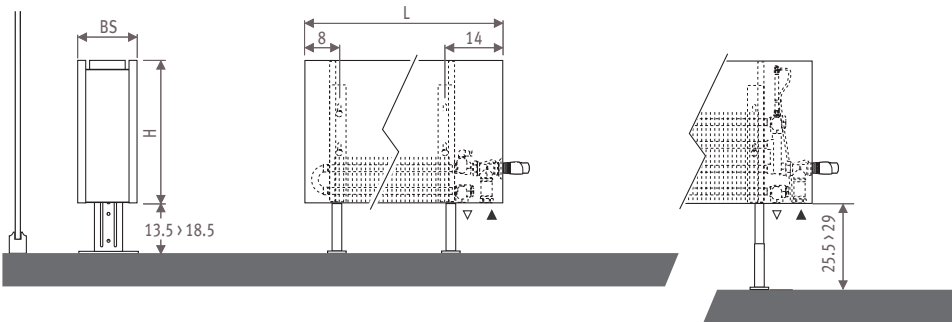

Connections

Jaga Comap valve to the wall

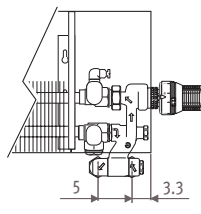
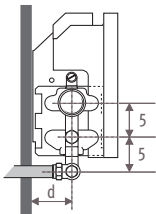

Jaga Comap valve to the floor

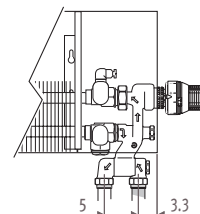
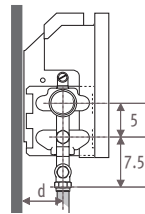

The valves offered by Jaga are totally concealed within the standard casing. Other valves may be partially visible. Detailed info: see Connection sets and valves.

Jaga Pro valve to the wall

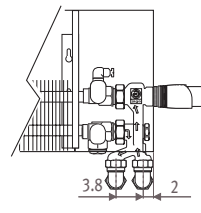
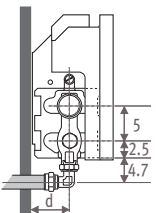

Jaga Pro valve to the floor

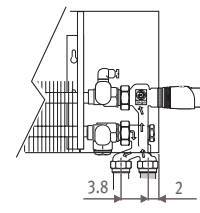
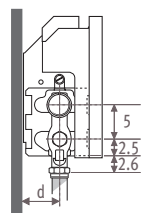

Jaga valve to the wall

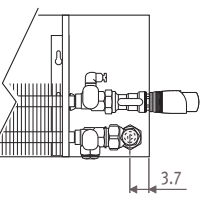
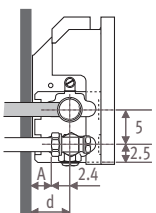

Jaga valve to the floor

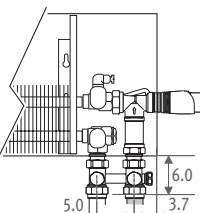
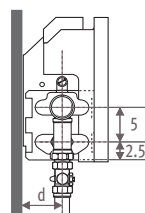

Type	d	A
10-11	5.3	2.9
15-16	7.8	5.3
20-21	10.3	7.9



Linea Plus_Options

Towel rail

min. length casing = 70 cm

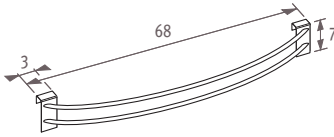

CODE
5500.011 xxx
fill in colour code

Extended air vent



For easy and rapid venting. Extended air vent for heat exchanger type 10, 15 and 20.

Standard delivered with type 11, 16 and 21.

CODE	casing
5090.114078	20
5090.114178	35
5090.114378	50
5090.114528	65
5090.114728	95

Top valve

(for all wall mounted models)

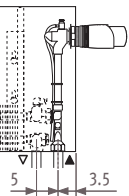

When ordering a top valve, add to the code of the Linea Plus /30 (top left) or /60 (top right).

Ex.: LINW. 035 050 10.xxx/60

CODE	H casing
5090.1300201 right	35
5090.1300202 left	35
5090.1300500 right and left	50
5090.1300800 right and left	65
5090.1301200 right and left	95

Thermostatic head not included: see Connection sets & valves page 178-179.

Brush

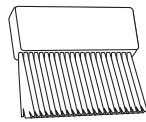

For easy cleaning of the underside of the Low-H₂O heat exchanger without detaching the casing.

CODE
5090.001

Free-standing model with feet in the colour of the appliance

The feet (standard in neutral grey lacquered) are also deliverable in the same colour as the apparatus. For this repeat the colour code after the code of the apparatus.

Ex.: LINF. HHH LLL TT.xxx/xxx

EXTRA CHARGE	
Length casing r	
050 > 110	(2 feet)
120 > 220	(3 feet)
240 > 280	(4 feet)

Free-standing model with extended adjustable feet

- For extended feet in neutral grey, with a height of 25.5 to 29 cm, add /AL to the ordering code. Ex.: LINF. 020 050 10. xxx/AL
- For extended feet in the same colour as the casing, with a height of 25.5 to 29 cm, add /AL to the ordering code and repeat the colour code. Ex.: LINF. 020 050 10. xxx/AL/xxx

EXTRA CHARGE	
Length casing	
050 > 110	(2 feet)
120 > 220	(3 feet)
240 > 280	(4 feet)

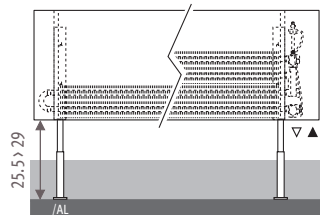

Fixing calorimeter holder

See Special Products.

DBE & Oxygen version

DBE: the smallest and most powerful radiator.

Oxygen: for healthy heat and clean air.

See price list "Top performers".

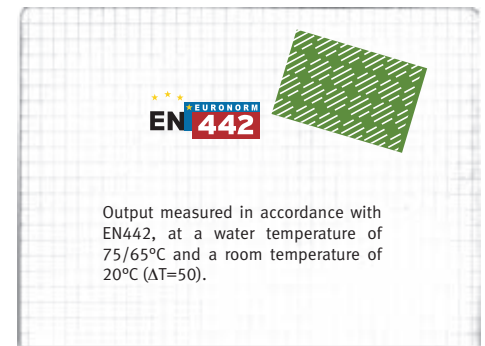

Linea Plus_Wall mounted model

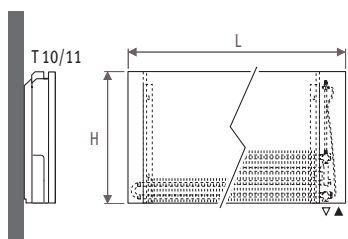

Standard delivery

- colour 133, 101 or 001
- Low-H₂O heat exchanger type 10 or Twin type 11
- wall brackets
- complete casing
- fixing kit
- air vent 1/8": elbow (type 10) or extended (type 11)
- drain cock 1/2"

Connection

- standard connection: bottom end left or right, valve position 20 or 70
- for option top valve, add to the code of the Linea Plus /30 (top left) or /60 (top right)
ex.: LINW. 035 050 10.xxx/60
- remote controlled valve also possible with the standard casing

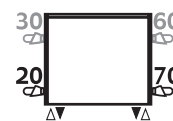

Wall mounted model_type 10

ORDERING CODE: LINW. *code* *height* *length* *type* *colour*
10. 020 050 xxx

H	L	050	060	070	080	090	100	110	120	140	160	180	200	220	240	260	280
020	75/65/20	284	341	398	454	511	568	625	682	795	909	1022	1136	1250	1363	1477	1590
	90/70/20	369	443	517	590	664	738	812	886	1033	1181	1328	1476	1624	1771	1919	2066
035	75/65/20	393	471	550	628	707	785	864	942	1099	1256	1413	1570	1727	1884	2041	2198
	90/70/20	509	610	712	813	916	1017	1119	1220	1423	1627	1830	2034	2237	2440	2644	2847
050	75/65/20	482	578	675	771	868	964	1060	1157	1350	1542	1735	1928	2121	2314	2506	2699
	90/70/20	622	746	872	996	1121	1245	1369	1494	1743	1991	2240	2490	2739	2988	3236	3485
065	75/65/20	561	673	785	897	1009	1121	1233	1345	1569	1794	2018	2242	2466	2690	2915	3139
	90/70/20	722	866	1010	1155	1299	1443	1587	1731	2020	2309	2598	2886	3174	3463	3752	4041
095	75/65/20	---	838	977	1117	1256	1396	1536	1675	1954	---	---	---	---	---	---	---
	90/70/20	---	1072	1250	1429	1607	1786	1965	2142	2499	---	---	---	---	---	---	---

Wall mounted model Twin_type 11



ORDERING CODE: LINW. *code* *height* *length* *type* *colour*
11. 035 050 xxx

H	L	050	060	070	080	090	100	110	120	140	160	180	200	220	240	260	280
035	75/65/20	549	659	769	878	988	1098	1208	1318	1537	1757	1976	2196	2416	2635	2855	3074
	90/70/20	716	860	1004	1146	1289	1433	1576	1720	2006	2293	2579	2866	3153	3439	3726	4012
050	75/65/20	655	785	916	1047	1178	1309	1440	1571	1833	2094	2356	2618	2880	3142	3403	3665
	90/70/20	854	1023	1194	1365	1536	1707	1877	2048	2390	2730	3072	3413	3755	4097	4437	4778
065	75/65/20	742	890	1038	1186	1335	1483	1631	1780	2076	2373	2669	2966	3263	3559	3856	4152
	90/70/20	967	1159	1352	1545	1739	1932	2125	2319	2704	3091	3477	3864	4250	4636	5023	5408
095	75/65/20	---	1055	1231	1406	1582	1758	1934	2110	2461	---	---	---	---	---	---	---
	90/70/20	---	1372	1601	1828	2057	2286	2515	2744	3200	---	---	---	---	---	---	---

Linea Plus_Wall mounted model

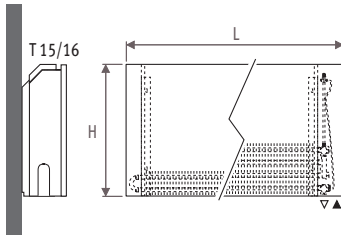

Standard delivery

- colour 133, 101 or 001
- Low-H₂O heat exchanger type 15 or Twin type 16
- wall brackets
- complete casing
- fixing kit
- air vent 1/8": elbow (type 15) or extended (type 16)
- drain cock 1/2"

Connection

- standard connection: bottom end left or right, valve position 20 or 70
- for option top valve, add to the code of the Linea Plus /30 (top left) or /60 (top right)
- ex.: LINW. 035 050 15.xxx/60
- remote controlled valve also possible with the standard casing

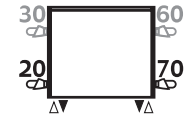

Wall mounted model_type 15

ORDERING CODE: LINW.																	code	height	length	type	colour
H	L	050	060	070	080	090	100	110	120	140	160	180	200	220	240	260	280	020	050	15.	xxx
020	75/65/20	519	623	727	830	934	1038	1142	1246	1453	1661	1868	2076	2284	2491	2699	2906				
	90/70/20	673	808	943	1076	1211	1346	1481	1615	1884	2153	2422	2691	2961	3229	3499	3767				
035	75/65/20	659	790	922	1054	1185	1317	1449	1580	1844	2107	2371	2634	2897	3161	3424	3688				
	90/70/20	850	1019	1190	1360	1529	1699	1870	2039	2379	2719	3059	3399	3738	4079	4418	4759				
050	75/65/20	767	920	1073	1226	1380	1533	1686	1840	2146	2453	2759	3066	3373	3679	3986	4292				
	90/70/20	985	1181	1378	1574	1772	1969	2165	2363	2756	3150	3543	3937	4332	4725	5119	5512				
065	75/65/20	858	1029	1201	1372	1544	1715	1887	2058	2401	2744	3087	3430	3773	4116	4459	4802				
	90/70/20	1096	1315	1535	1753	1973	2192	2411	2630	3068	3507	3945	4383	4822	5260	5698	6137				
095	75/65/20	---	1210	1411	1613	1814	2016	2218	2419	2822	---	---	---	---	---	---	---				
	90/70/20	---	1532	1786	2042	2296	2552	2808	3062	3572	---	---	---	---	---	---	---				

Wall mounted model Twin_type 16



ORDERING CODE: LINW.																	code	height	length	type	colour
H	L	050	060	070	080	090	100	110	120	140	160	180	200	220	240	260	280	035	050	16.	xxx
035	75/65/20	813	975	1138	1300	1463	1625	1788	1950	2275	2600	2925	3250	3575	3900	4225	4550				
	90/70/20	1062	1274	1486	1698	1911	2123	2335	2547	2972	3396	3821	4245	4670	5094	5519	5943				
050	75/65/20	976	1171	1366	1561	1756	1951	2146	2341	2731	3122	3512	3902	4292	4682	5073	5463				
	90/70/20	1274	1529	1784	2038	2293	2547	2802	3057	3566	4076	4586	5095	5604	6113	6624	7133				
065	75/65/20	1114	1336	1559	1782	2004	2227	2450	2672	3118	3563	4009	4454	4899	5345	5790	6236				
	90/70/20	1454	1743	2034	2325	2615	2906	3197	3487	4069	4650	5232	5812	6393	6975	7556	8138				
095	75/65/20	---	1608	1876	2144	2412	2680	2948	3216	3752	---	---	---	---	---	---	---				
	90/70/20	---	2096	2446	2795	3145	3494	3844	4193	4892	---	---	---	---	---	---	---				

Linea Plus_Wall mounted model

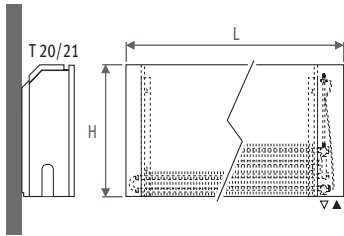

Standard delivery

- colour 133, 101 or 001
- Low-H₂O heat exchanger type 20 or Twin type 21
- wall brackets
- complete casing
- fixing kit
- air vent 1/8": elbow (type 20) or extended (type 21)
- drain cock 1/2"

Connection

- standard connection: bottom end left or right, valve position 20 or 70
- for option top valve, add to the code of the Linea Plus /30 (top left) or /60 (top right)
ex.: LINW. 035 050 20.xxx/60
- remote controlled valve also possible with the standard casing

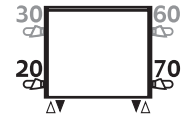

Wall mounted model_type 20

ORDERING CODE: LINW. *code* *height* *length* *type* *colour*
020 050 20. xxx

H	L	050	060	070	080	090	100	110	120	140	160	180	200	220	240	260	280
020	75/65/20	697	836	976	1115	1255	1394	1533	1673	1952	2230	2509	2788	3067	3346	3624	3903
	90/70/20	904	1084	1266	1446	1627	1808	1988	2169	2531	2892	3253	3615	3977	4339	4699	5061
035	75/65/20	901	1081	1261	1441	1621	1801	1981	2161	2521	2882	3242	3602	3962	4322	4683	5043
	90/70/20	1163	1395	1627	1860	2092	2324	2557	2789	3253	3719	4184	4649	5113	5578	6044	6508
050	75/65/20	1060	1272	1484	1696	1908	2120	2332	2544	2968	3392	3816	4240	4664	5088	5512	5936
	90/70/20	1362	1634	1906	2178	2451	2723	2995	3268	3812	4357	4901	5446	5991	6535	7080	7624
065	75/65/20	1196	1435	1674	1913	2152	2391	2630	2869	3347	3826	4304	4782	5260	5738	6217	6695
	90/70/20	1529	1835	2140	2446	2752	3057	3363	3668	4279	4892	5503	6114	6725	7337	7949	8560
095	75/65/20	---	1706	1991	2275	2560	2844	3128	3413	3982	---	---	---	---	---	---	---
	90/70/20	---	2161	2522	2881	3242	3602	3962	4323	5043	---	---	---	---	---	---	---

Wall mounted model Twin_type 21



ORDERING CODE: LINW. *code* *height* *length* *type* *colour*
035 050 21. xxx

H	L	050	060	070	080	090	100	110	120	140	160	180	200	220	240	260	280
035	75/65/20	1039	1247	1455	1662	1870	2078	2286	2494	2909	3325	3740	4156	4572	4987	5403	5818
	90/70/20	1361	1634	1906	2177	2450	2722	2995	3267	3811	4356	4899	5444	5989	6533	7078	7622
050	75/65/20	1282	1538	1795	2051	2308	2564	2820	3077	3590	4102	4615	5128	5641	6154	6666	7179
	90/70/20	1681	2017	2354	2689	3026	3362	3698	4035	4707	5378	6051	6724	7396	8069	8740	9413
065	75/65/20	1503	1803	2104	2404	2705	3005	3306	3606	4207	4808	5409	6010	6611	7212	7813	8414
	90/70/20	1972	2366	2761	3154	3549	3943	4338	4732	5520	6309	7097	7886	8675	9463	10252	11040
095	75/65/20	---	2290	2671	3053	3434	3816	4198	4579	5342	---	---	---	---	---	---	---
	90/70/20	---	3010	3510	4013	4513	5015	5517	6018	7021	---	---	---	---	---	---	---

Linea Plus_Free-standing model

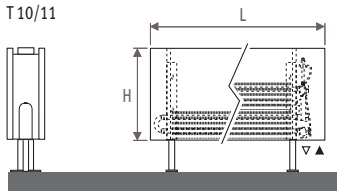

Standard delivery type 10

- colour 133, 101 or 001
- Low-H₂O heat exchanger type 10
- brackets
- complete casing
- adjustable feet in neutral grey
- air vent elbow 1/8"
- drain cock 1/2"

Standard delivery type 11

- colour 133, 101 or 001
- Twin Low-H₂O heat exchanger type 11
- brackets
- complete casing
- adjustable feet in neutral grey
- extended air vent 1/8"
- drain cock 1/2"

Connection

Top valve: add /30 (left) or /60 (right).

Ex.: LINF. 035 050 10 xxx/60

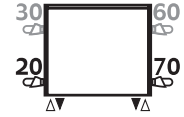

Free-standing model_type 10

		ORDERING CODE:																code	height	length	type	colour	
		L	050	060	070	080	090	100	110	120	140	160	180	200	220	240	260	280	LINF.	020	050	10.	xxx
020	75/65/20		271	325	379	433	487	541	595	649	757	866	974	1082	1190	1298	1407	1515					
	90/70/20		352	422	492	563	633	703	773	843	984	1125	1266	1406	1546	1686	1828	1968					
035	75/65/20		392	470	548	626	705	783	861	940	1096	1253	1409	1566	1723	1879	2036	2192					
	90/70/20		508	609	710	811	913	1014	1115	1218	1420	1623	1825	2028	2232	2434	2637	2839					
050	75/65/20		483	580	676	773	869	966	1063	1159	1352	1546	1739	1932	2125	2318	2512	2705					
	90/70/20		624	749	873	998	1122	1247	1373	1497	1746	1996	2245	2495	2744	2993	3244	3493					

Free-standing model Twin_type 11



		ORDERING CODE:																code	height	length	type	colour	
		L	050	060	070	080	090	100	110	120	140	160	180	200	220	240	260	280	LINF.	035	050	11.	xxx
035	75/65/20		524	629	734	838	943	1048	1153	1258	1467	1677	1886	2096	2306	2515	2725	2934					
	90/70/20		684	821	958	1094	1231	1368	1505	1642	1914	2188	2461	2735	3009	3282	3556	3829					
050	75/65/20		625	750	875	1000	1125	1250	1375	1500	1750	2000	2250	2500	2750	3000	3250	3500					
	90/70/20		815	978	1141	1304	1467	1630	1793	1956	2282	2608	2934	3259	3585	3911	4237	4563					

Linea Plus_Free-standing model

T20/21

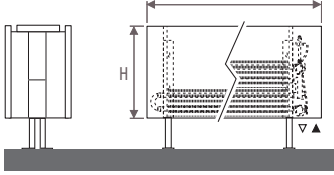

Standard delivery type 20

- colour 133, 101 or 001
- Low-H₂O heat exchanger type 20
- brackets
- complete casing
- adjustable feet in neutral grey
- air vent elbow 1/8"
- drain cock 1/2"

Standard delivery type 21

- colour 133, 101 or 001
- Twin Low-H₂O heat exchanger type 21
- brackets
- complete casing
- adjustable feet in neutral grey
- extended air vent 1/8"
- drain cock 1/2"

Connection

Top valve: add /30 (left) or /60 (right).

Ex.: LINF. 035 050 20 xxx/60

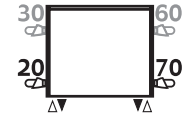

Free-standing model_type 20

		ORDERING CODE:																code	height	length	type	colour
																		LINF.	020	050	20.	xxx
H		050	060	070	080	090	100	110	120	140	160	180	200	220	240	260	280					
020	75/65/20	632	758	885	1011	1138	1264	1390	1517	1770	2022	2275	2528	2781	3034	3286	3539					
	90/70/20	820	983	1148	1311	1476	1639	1802	1967	2295	2622	2950	3278	3606	3934	4261	4589					
035	75/65/20	879	1055	1231	1406	1582	1758	1934	2110	2461	2813	3164	3516	3868	4219	4571	4922					
	90/70/20	1134	1362	1589	1815	2042	2269	2496	2723	3176	3630	4083	4538	4992	5445	5899	6352					
050	75/65/20	1046	1255	1464	1673	1882	2091	2300	2509	2927	3346	3764	4182	4600	5018	5437	5855					
	90/70/20	1344	1612	1880	2149	2417	2686	2954	3223	3760	4298	4835	5372	5908	6445	6984	7520					

Free-standing model Twin_type 21



		ORDERING CODE:																code	height	length	type	colour
																		LINF.	035	050	21.	xxx
H		050	060	070	080	090	100	110	120	140	160	180	200	220	240	260	280					
035	75/65/20	907	1088	1269	1450	1632	1813	1994	2176	2538	2901	3263	3626	3989	4351	4714	5076					
	90/70/20	1188	1425	1662	1899	2138	2375	2612	2851	3325	3800	4274	4750	5226	5700	6175	6650					
050	75/65/20	1118	1342	1565	1789	2012	2236	2460	2683	3130	3578	4025	4472	4919	5366	5814	6261					
	90/70/20	1466	1760	2052	2346	2638	2932	3226	3518	4104	4691	5278	5864	6450	7036	7623	8209					