



Sani Louvre



Sani Louvre

Dimensions

SLOW _Sani Louvre Wall

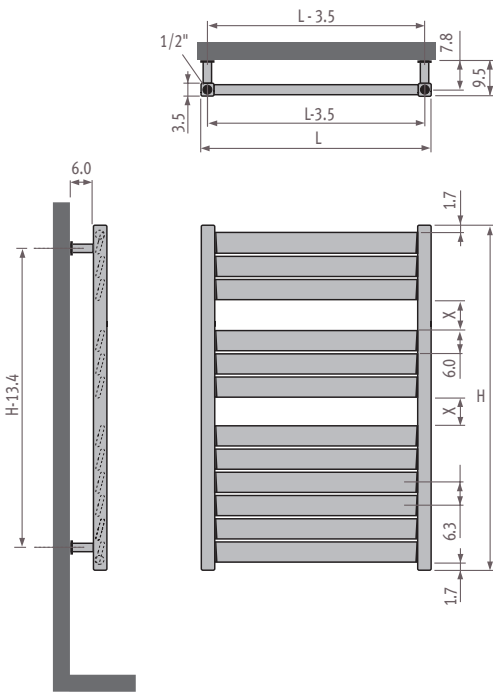

Dimensions in cm

H	73	93	119	139	178	205
X	7.3	7.8	7.6	7.8	7.8	9.0

Range

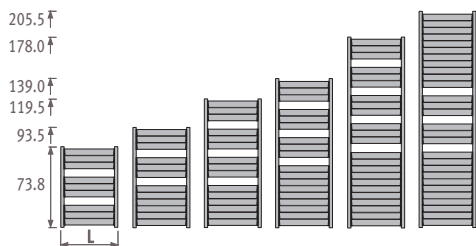

Connections

Code: 1° number = flow
2° number = return

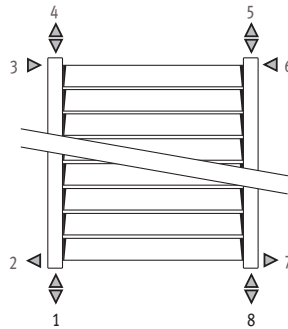

Standard connection

Code 18
Connection 18 or 81

Top end connection

Ordering code specify 45 or 54 instead of 18. Insert pipe included without surcharge, to be mounted in the return, provide an air vent on the central heating tube. No surcharge.

Side end connection

Ordering code specify 32, 67, 41 or 58 instead of 18, no surcharge.

Single point connection

Ordering code: specify code 11 or 88 instead of 18. In case of single point connection always use a diffusion tube of min. length of 100 mm (Ø 10 up to 12 mm) with a reduction washer. Not possible with a radiator on feet.

With electric element

Ordering code: standard code 18, and order an electric element. Not possible with a radiator on feet.



Mixed

Ordering code: standard code 18. Order an electric element and T-pieces.

- Fit the T-piece together with the electrical heating element for connection to the central heating wet system.

- Never isolate the radiator from the expansion system, in other words never cut off the return of the radiator. Not possible with a radiator on feet.



Fixings

Standard wall fixing

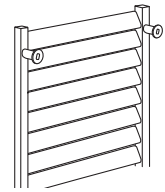

Ceiling fixing

The ceiling fixing is identical to the feet. It has however a length of 50 cm which can be adapted by the contractor on site.

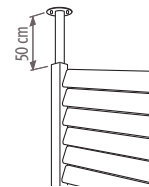

Feet

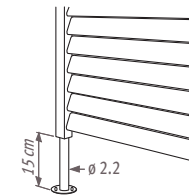

Side end fixing

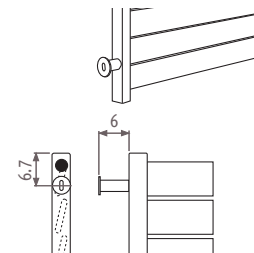

Configurations on size: see parts.

Outputs

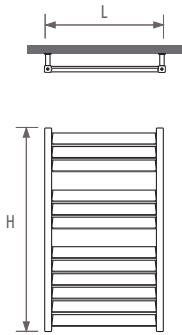

Standard delivery

- connection 18 underneath
- wall fixing
- chrome-plated air vent and drain cock

Standard colours:

- white (233) RAL 9016 glossy
- white (201) RAL 9010 glossy
- sandblast grey metallic (001)

Surcharge for freestanding model SLOF

Description:

- 2 feet
- 2 ceiling fixings
- 3 chrome-plated T-pieces 1/2"
- 1 chrome-plated air vent 1/2"

Freestanding models available in heights 178 and 205 cm.



Ex. **SLOF.** 178 040. XXX/18

Sani Louvre		code	height	length	colour	conn.
ORDERING CODE:		SLOW.	073	040.	XXX	/18

H		L 040	050	060	070	080	100
073	75/65/20	352	419	487	554	621	756
	90/70/20	446	531	619	705	791	964
093	75/65/20	469	559	649	739	829	1009
	90/70/20	593	709	824	939	1054	1285
119	75/65/20	585	696	808	920	1032	1255
	90/70/20	739	881	1025	1168	1311	1597
139	75/65/20	697	830	963	1096	1229	1494
	90/70/20	880	1050	1220	1390	1560	1899
178	75/65/20	879	1045	1211	1377	1543	1876
	90/70/20	1109	1320	1532	1744	1955	2380
205	75/65/20	1053	1250	1447	1644	1841	2234
	90/70/20	1326	1577	1828	2078	2329	2829

CODE

Code **SLOF**
instead of **SLOW**

Surcharge for positioning perpendicular to the wall SLOS

Description:

- 2 side end fixings
- 1 foot
- 1 chrome-plated air vent 1/2"

Surcharge for positioning perpendicular to the wall available in heights 178 and 205 cm.

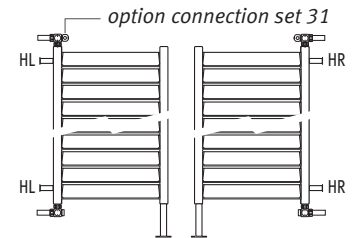

Ex. **SLOS.** 178 040. XXX/41/HL

Ex. **SLOS.** 178 040. XXX/58/HR

CODE

Code **SLOS**
instead of **SLOW**



Output measured in accordance with EN442, at a water temperature of 75/65 and a room temperature of 20°C ($\Delta T=50$).



Options

Electro heating

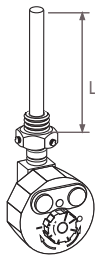

CODE	WATTS	L
9096.10	450	31.5
9096.11	600	35.5
9096.12	900	51.5
9096.13	1200	66.0
9096.14	1500	82.0

Electro heating element with infra-red operation

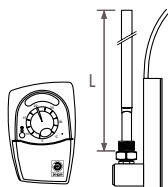

- Finish: white ABS
- Transmission range: ± 6 m in all directions
 - Receiver has to be placed at the back of the radiator
 - Insulation Class 1

CODE	WATTS	L
9096.510	600	47
9096.520	900	68

Electric element Eco Comfort

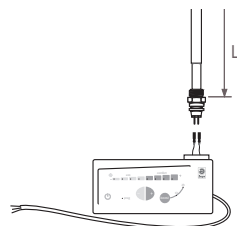

CODE	WATTS	L
9096.70	600	55.0
9096.71	750	60.0
9096.72	900	69.5
9096.73	1000	72.0
9096.74	1250	85.0
9096.75	1500	96.5

Connection electric element

- Fit the electric heating element vertically in the socket 1 or 8. The pressure release valve which is included should be fitted into socket 4 or 5, (3 bar).
- Do not switch the radiator on before filling it completely with water.
- Top up with water after the first total heating up of the radiator.

For more information see *Technical info*.

T-piece for mixed application

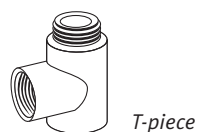

Combination possibilities with T-piece

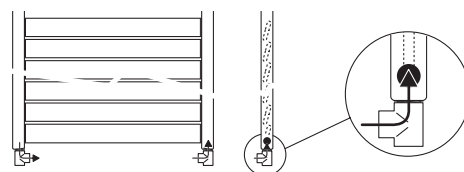

Connection at side or the back with a standard radiator

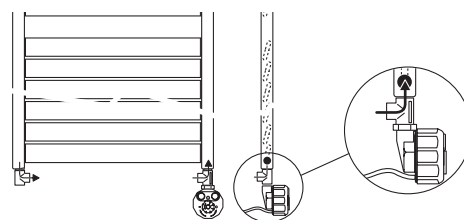

Mixed connection

CODE	colour
TPCE.004.009	chrome
TPCE.004.XXX	201 up to 233
	301 up to 333
<i>fill in colour code</i>	

Insert pipe for top end connection

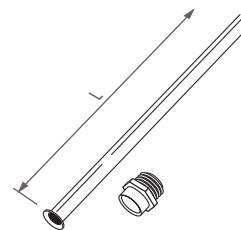

Will be delivered without surcharge if the top end connection code is indicated 45 or 54 instead of 18.

CODE	H radiator	L
9097.0540	73	54
9097.0840	93	84
9097.1100	119	110
9097.1280	139	128
9097.1660	178	166
9097.1960	205	196

