

Strada

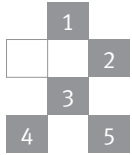

design award
winner
2003

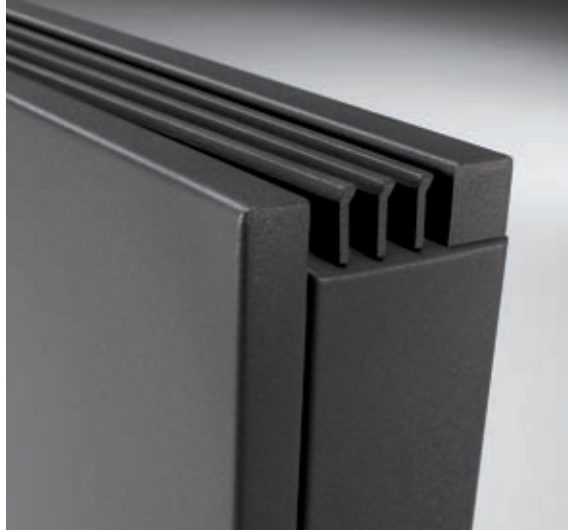

1. Aluminium grille, lacquered in the same colour as the casing
2. Complete flat front panel
3. Thermostatic valve is totally concealed
4. Optional towel rail
5. Can be connected left or right as standard



Strada_Dimensions

LOW
H₂O
30
YEARS GUARANTEE



STRW_STRAda Wall

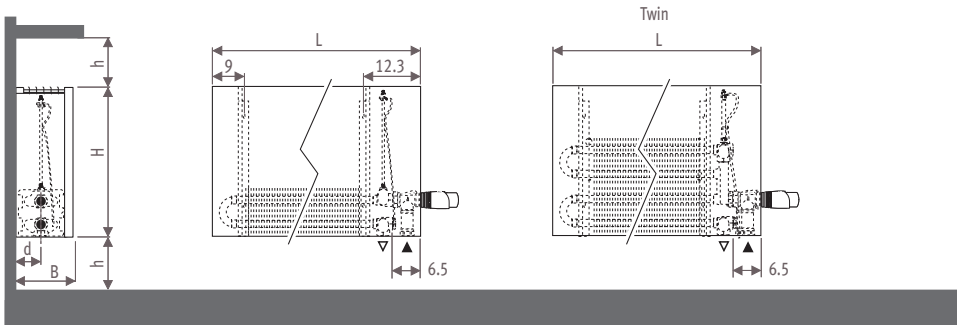

Dimensions in cm

Type	B	d	h min*
06	8.5	4.0	10
10-11	11.8	5.2	10
15-16	16.8	7.7	12
20-21	21.8	10.2	15

* Smaller dimensions can decrease output.

Connections

Jaga Comap valve to the wall

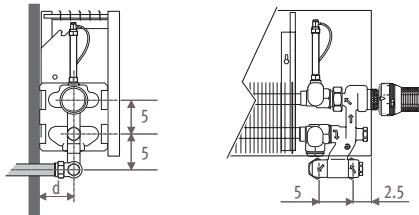

Jaga Comap valve to the floor

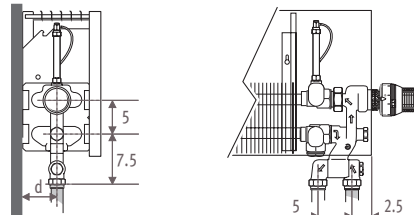

The valves offered by Jaga are totally concealed within the standard casing. Detailed info: see Connection sets and valves.

Jaga Pro valve to the wall

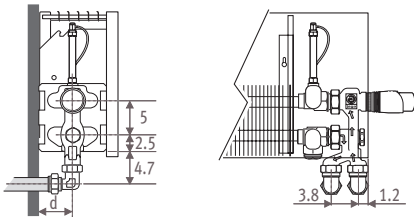

Jaga Pro valve to the floor

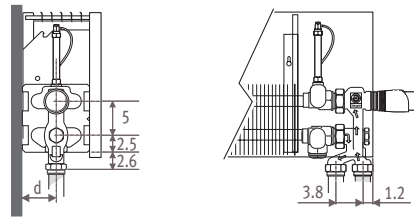

Jaga valve to the wall

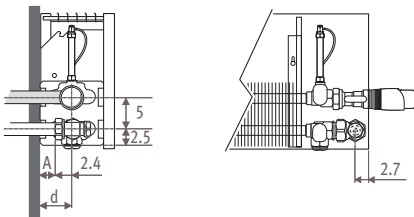

Jaga valve to the floor

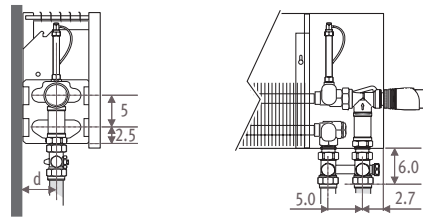

Jaga type 6 valve to the wall

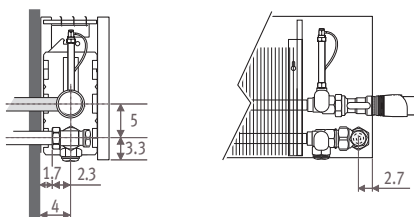

The Jaga Type 6 valve: with short connection distance, special for Strada type 06 connection to the wall. See p. 167-175.

Type	d	A
06	4.0	1.8
10-11	5.2	2.9
15-16	7.7	5.3
20-21	10.2	7.9



Strada_Options

Top valve

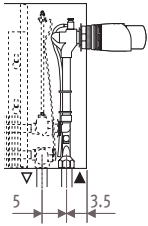

When ordering a top valve, add to the code of the Strada /30 (top left) or /60 (top right).
Ex.: STRW. 035 050 06.xxx/60

DBE & Oxygen version

DBE: the smallest and most powerful radiator.

Oxygen: for healthy heat and clean air.
See price list "Top performers".

CODE	H casing
5090.1300200	35
5090.1300500	50
5090.1300800	65
5090.1301200	95

Thermostatic head not included: see Connection sets & valves page 178-179.

Towel rail in chrome-plated aluminium

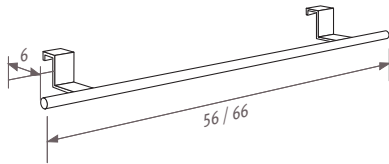

CODE	L
5501.001	56
5501.002	66

Brush



For easy cleaning of the underside of the Low-H₂O heat exchanger without detaching the casing.

CODE

5090.001



EURONOR
EN 442

Output measured in accordance with EN442, at a water temperature of 75/65°C and a room temperature of 20°C (ΔT=50).



Strada_Wall mounted model

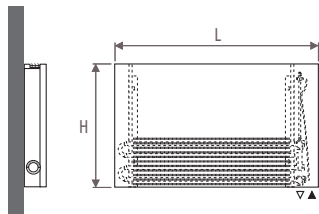

Standard delivery

- colour 133, 101 or 001
- Twin Low-H₂O heat exchanger type 07 or 08
- wall brackets
- complete casing
- fixing kit
- extended air vent 1/8"
- drain cock 1/2"

Connection

- standard connection: bottom end left or right, 20 or 70
- for option top valve, add to the code of the Strada /30 (top left) or /60 (top right)
- ex.: STRW. 035 050 06.xxx/60
- for remote controlled valve: see Special products

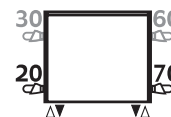

Wall mounted model Twin_type 06



ORDERING CODE: STRW. *code* *height* *length* *type* *colour*
020 050 06. xxx

H		L 050	060	070	080	090	100	110	120	140	160	180	200	240	280
020	75/65/20	269	323	377	430	484	538	592	646	753	861	968	1076	1291	1506
	90/70/20	348	418	488	556	626	696	766	835	974	1113	1252	1391	1669	1947
035	75/65/20	395	474	553	632	711	790	869	948	1106	1264	1422	1580	1896	2212
	90/70/20	509	611	713	815	917	1018	1120	1222	1426	1629	1833	2037	2444	2852
050	75/65/20	474	568	663	758	852	947	1042	1136	1326	1515	1705	1894	2273	2652
	90/70/20	609	729	851	973	1094	1216	1338	1459	1703	1946	2190	2432	2919	3406
065	75/65/20	533	640	746	853	959	1066	1173	1279	1492	1706	1919	2132	2558	2985
	90/70/20	682	819	954	1091	1227	1363	1500	1636	1908	2182	2455	2727	3272	3818
095	75/65/20	---	736	858	981	1103	1226	1349	1471	1716	---	---	---	---	---
	90/70/20	---	934	1089	1245	1400	1556	1712	1867	2178	---	---	---	---	---

Strada_Wall mounted model

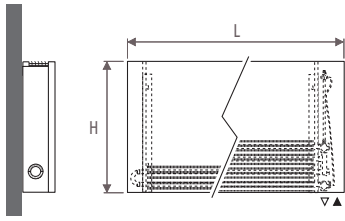

Standard delivery

- colour 133, 101 or 001
- Low-H₂O heat exchanger type 10 or Twin type 11
- wall brackets
- complete casing
- fixing kit
- extended air vent 1/8"
- drain cock 1/2"

Connection

- standard connection: bottom end left or right, valve position 20 or 70
- for option top valve, add to the code of the Strada /30 (top left) or /60 (top right)
ex.: STRW. 035 050 10.xxx/60
- for remote controlled valve: see Special products

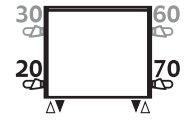

Wall mounted model_type 10

ORDERING CODE: STRW. *code* *height* *length* *type* *colour*
020 050 10. xxx

H		L 050	060	070	080	090	100	110	120	140	160	180	200	240	280
020	75/65/20	328	393	459	524	590	655	721	786	917	1048	1179	1310	1572	1834
	90/70/20	424	508	594	678	763	847	933	1017	1186	1356	1525	1695	2034	2373
035	75/65/20	449	539	629	718	808	898	988	1078	1257	1437	1616	1796	2155	2514
	90/70/20	579	696	812	927	1043	1159	1275	1391	1622	1855	2086	2318	2781	3244
050	75/65/20	538	646	753	861	968	1076	1184	1291	1506	1722	1937	2152	2582	3013
	90/70/20	693	832	969	1108	1246	1385	1524	1662	1939	2217	2493	2770	3324	3879
065	75/65/20	606	727	848	969	1090	1211	1332	1453	1695	1938	2180	2422	2906	3391
	90/70/20	778	933	1089	1244	1400	1555	1710	1866	2176	2488	2799	3110	3731	4354
095	75/65/20	---	836	975	1114	1254	1393	1532	1672	1950	---	---	---	---	---
	90/70/20	---	1068	1246	1423	1602	1779	1957	2136	2491	---	---	---	---	---

Wall mounted model Twin_type 11



ORDERING CODE: STRW. *code* *height* *length* *type* *colour*
035 050 11. xxx

H		L 050	060	070	080	090	100	110	120	140	160	180	200	240	280
035	75/65/20	598	718	837	957	1076	1196	1316	1435	1674	1914	2153	2392	2870	3349
	90/70/20	778	934	1088	1244	1399	1555	1711	1866	2177	2489	2799	3110	3732	4354
050	75/65/20	693	832	970	1109	1247	1386	1525	1663	1940	2218	2495	2772	3326	3881
	90/70/20	901	1081	1261	1441	1621	1801	1982	2161	2522	2883	3243	3603	4323	5044
065	75/65/20	772	926	1080	1234	1389	1543	1697	1852	2160	2469	2777	3086	3703	4320
	90/70/20	1003	1203	1403	1604	1805	2005	2205	2407	2807	3209	3609	4010	4812	5614
095	75/65/20	---	1078	1257	1437	1616	1796	1976	2155	2514	---	---	---	---	---
	90/70/20	---	1400	1633	1866	2099	2333	2566	2799	3265	---	---	---	---	---

Strada_Wall mounted model

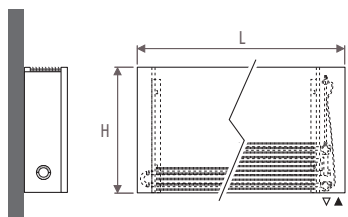

Standard delivery

- colour 133, 101 or 001
- Low-H₂O heat exchanger type 15 or Twin type 16
- wall brackets
- complete casing
- fixing kit
- extended air vent 1/8"
- drain cock 1/2"

Connection

- standard connection: bottom end left or right, valve position 20 or 70
- for option top valve, add to the code of the Strada /30 (top left) or /60 (top right)
ex.: STRW. 035 050 15.xxx/60
- for remote controlled valve: see Special products

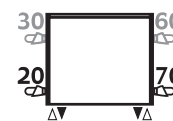

Wall mounted model_type 15

code height length type colour
ORDERING CODE: STRW. 020 050 15. xxx

H		L 050	060	070	080	090	100	110	120	140	160	180	200	240	280
020	75/65/20	545	654	763	872	981	1090	1199	1308	1526	1744	1962	2180	2616	3052
	90/70/20	705	845	986	1127	1268	1409	1550	1691	1973	2254	2536	2818	3382	3945
035	75/65/20	735	882	1029	1176	1323	1470	1617	1764	2058	2352	2646	2940	3528	4116
	90/70/20	947	1136	1326	1515	1705	1894	2083	2273	2652	3030	3409	3788	4546	5303
050	75/65/20	867	1040	1214	1387	1561	1734	1907	2081	2428	2774	3121	3468	4162	4855
	90/70/20	1114	1336	1559	1782	2005	2227	2449	2673	3119	3563	4009	4454	5346	6236
065	75/65/20	961	1153	1345	1538	1730	1922	2114	2306	2691	3075	3460	3844	4613	5382
	90/70/20	1230	1476	1722	1969	2215	2461	2706	2952	3445	3937	4430	4921	5906	6890
095	75/65/20	---	1288	1502	1717	1931	2146	2361	2575	3004	---	---	---	---	---
	90/70/20	---	1638	1911	2184	2456	2730	3003	3276	3821	---	---	---	---	---

Wall mounted model Twin_type 16



code height length type colour
ORDERING CODE: STRW. 035 050 16. xxx

H		L 050	060	070	080	090	100	110	120	140	160	180	200	240	280
035	75/65/20	797	956	1115	1274	1434	1593	1752	1912	2230	2549	2867	3186	3823	4460
	90/70/20	1040	1247	1455	1662	1871	2078	2285	2494	2909	3325	3740	4156	4987	5818
050	75/65/20	949	1139	1329	1518	1708	1898	2088	2278	2657	3037	3416	3796	4555	5314
	90/70/20	1239	1487	1736	1982	2231	2479	2727	2975	3470	3966	4461	4957	5949	6940
065	75/65/20	1087	1304	1521	1738	1956	2173	2390	2608	3042	3477	3911	4346	5215	6084
	90/70/20	1421	1705	1989	2272	2557	2841	3125	3410	3977	4546	5113	5682	6818	7954
095	75/65/20	---	1606	1874	2142	2409	2677	2945	3212	3748	---	---	---	---	---
	90/70/20	---	2104	2455	2807	3156	3507	3859	4208	4911	---	---	---	---	---

Strada_Wall mounted model

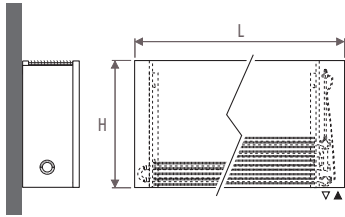

Standard delivery

- colour 133, 101 or 001
- Low-H₂O heat exchanger type 20 or Twin type 21
- wall brackets
- complete casing
- fixing kit
- extended air vent 1/8"
- drain cock 1/2"

Connection

- standard connection: bottom end left or right, valve position 20 or 70
- for option top valve, add to the code of the Strada /30 (top left) or /60 (top right)
ex.: STRW. 035 050 20.xxx/60
- for remote controlled valve: see Special products

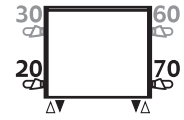

Wall mounted model_type 20

code height length type colour
ORDERING CODE: STRW. 020 050 20. xxx

H		L 050	060	070	080	090	100	110	120	140	160	180	200	240	280
020	75/65/20	766	919	1072	1226	1379	1532	1685	1838	2145	2451	2758	3064	3677	4290
	90/70/20	990	1188	1386	1585	1783	1980	2178	2376	2773	3168	3565	3961	4753	5546
035	75/65/20	1030	1236	1442	1648	1854	2060	2266	2472	2884	3296	3708	4120	4944	5768
	90/70/20	1327	1593	1858	2123	2389	2654	2920	3185	3716	4247	4778	5308	6370	7432
050	75/65/20	1213	1455	1698	1940	2183	2425	2668	2910	3395	3880	4365	4850	5820	6790
	90/70/20	1558	1869	2181	2492	2804	3115	3427	3738	4361	4984	5607	6230	7475	8721
065	75/65/20	1343	1611	1880	2148	2417	2685	2954	3222	3759	4296	4833	5370	6444	7518
	90/70/20	1719	2062	2407	2750	3094	3437	3782	4125	4812	5500	6187	6875	8250	9625
095	75/65/20	...	1795	2094	2394	2693	2992	3291	3590	4189
	90/70/20	...	2283	2664	3045	3426	3806	4186	4567	5329

Wall mounted model Twin_type 21



code height length type colour
ORDERING CODE: STRW. 035 050 21. xxx

H		L 050	060	070	080	090	100	110	120	140	160	180	200	240	280
035	75/65/20	1057	1268	1480	1691	1903	2114	2325	2537	2960	3382	3805	4228	5074	5919
	90/70/20	1382	1658	1936	2212	2489	2765	3041	3318	3871	4423	4976	5530	6636	7741
050	75/65/20	1291	1549	1807	2066	2324	2582	2840	3098	3615	4131	4648	5164	6197	7230
	90/70/20	1692	2031	2369	2708	3047	3385	3723	4061	4739	5416	6093	6770	8124	9478
065	75/65/20	1515	1818	2121	2424	2727	3030	3333	3636	4242	4848	5454	6060	7272	8484
	90/70/20	1990	2389	2787	3185	3583	3981	4379	4777	5573	6369	7166	7962	9554	11146
095	75/65/20	...	2352	2744	3136	3528	3920	4312	4704	5488
	90/70/20	...	3104	3622	4139	4656	5174	5691	6208	7243