

- 1. Taboe Sani
- 2. Taboe
- 3. Taboe Freestanding

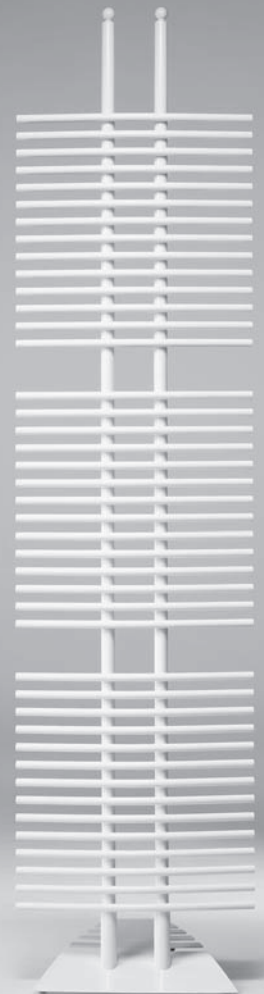

1

2

- 1. Taboe Sani Single
- 2. Taboe Sani Double

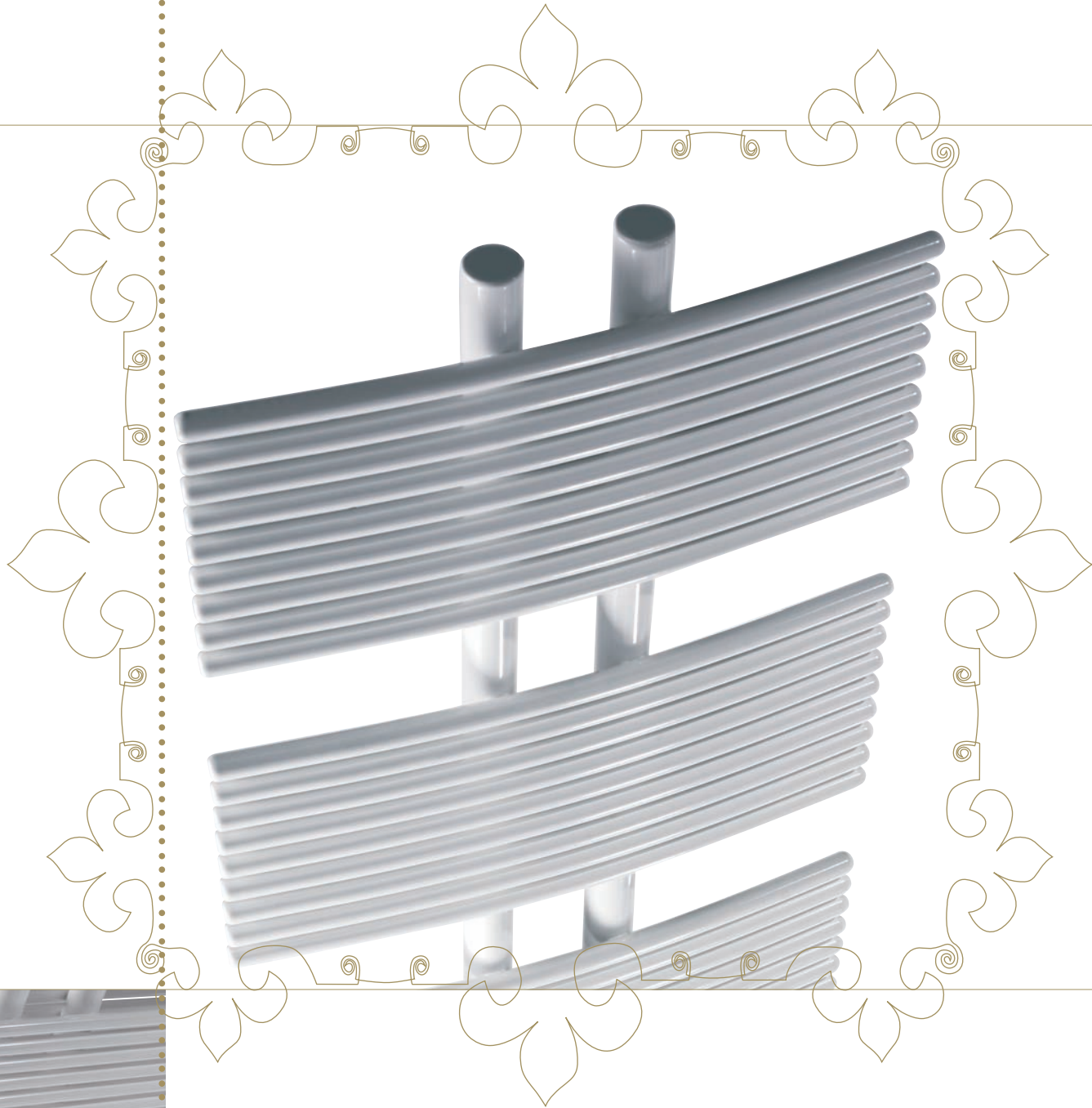

Taboe Sani

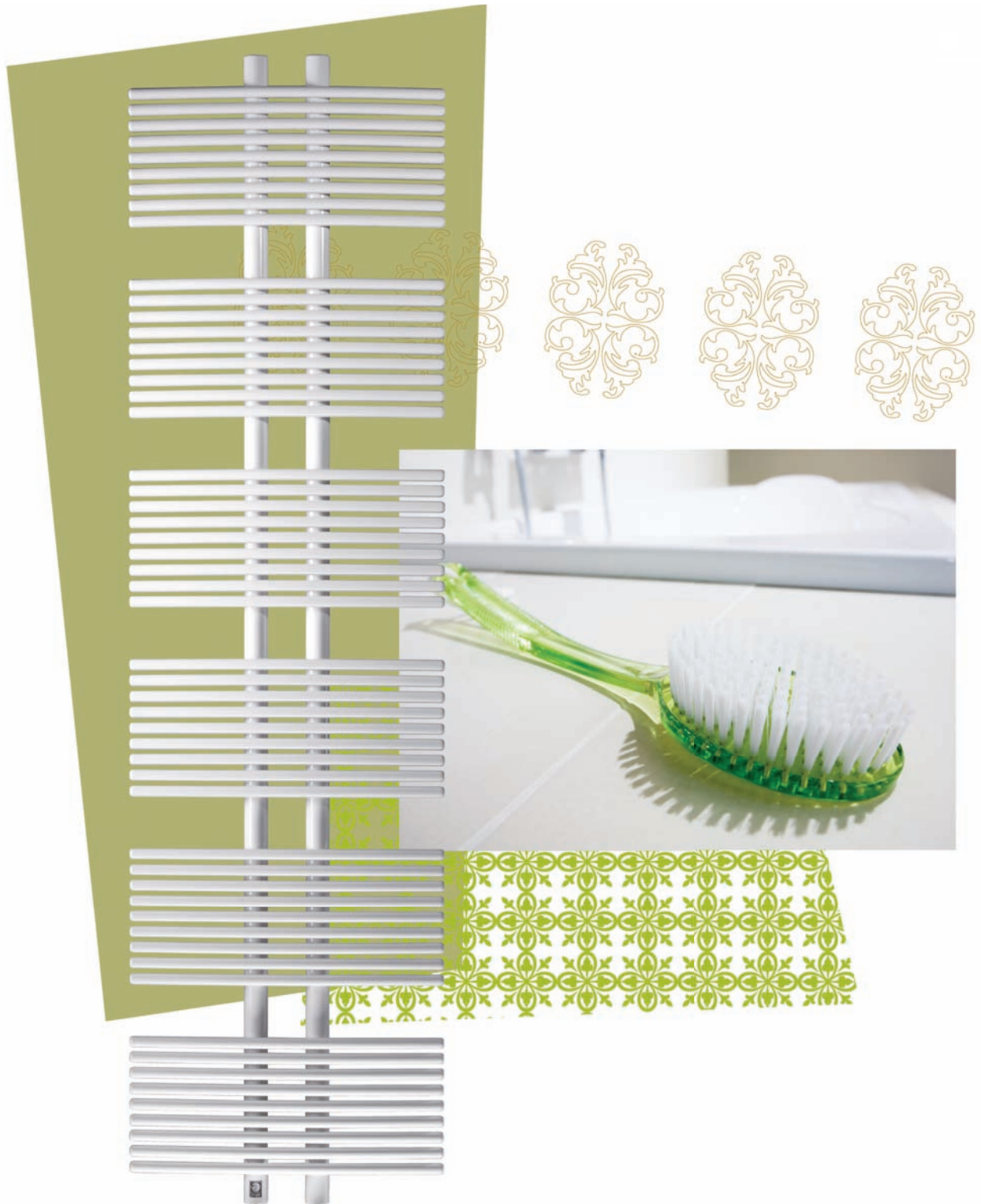

Taboe Sani

Dimensions

TSSW_Taboe Sani Single Wall

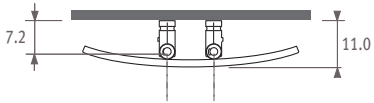

TSDW_Taboe Sani Double Wall

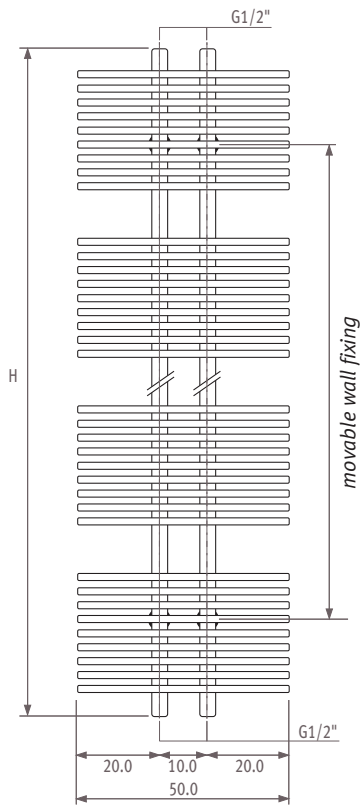
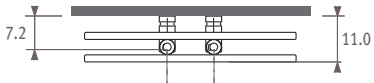

Connections

Code: 1° number = flow
2° number = return

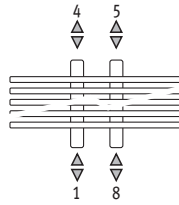

Standard connection

Code 18
Connection 18 or 81
To the floor:

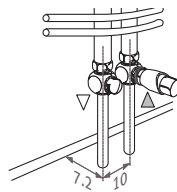

To the wall:

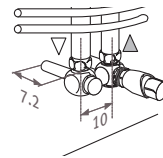

Top end connection

Ordering code: specify 45 or 54 instead of 18.
Insert pipe is delivered without surcharge, to be mounted in the return. Provide an air vent on the central heating tube.

With electric element

Ordering code: Standard code 18, and order an electric element.

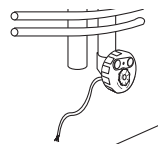

Mixed

Ordering code: standard code 18.
Order an electric element and T-piece.
- Fit the T-piece together with the electric heating element for connection to the central heating wet system.
- Never isolate the radiator from the expansion system, in other words never cut off the return of the radiator.

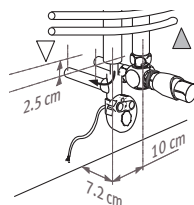

Range

Single

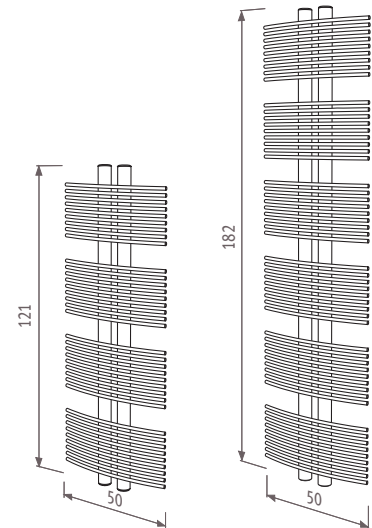

Double

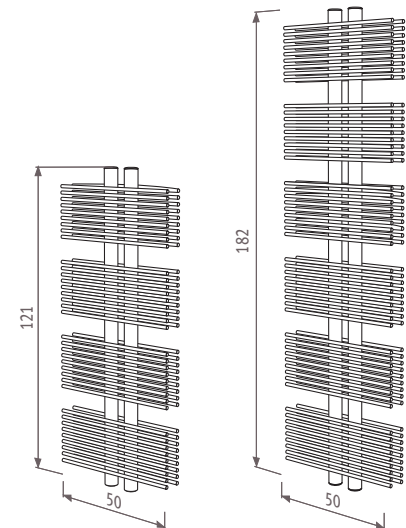

Outputs

Taboe Sani_single		<i>code</i>	<i>height</i>	<i>length</i>	<i>colour</i>	<i>conn.</i>
		ORDERING CODE: TSSW.	121	050.	XXX	/18

H	L 050	
121	75/65/20 90/70/20	590 759

Standard delivery

- central connection 18 underneath
- wall fixing set
- chrome-plated air vent and drain cock

Standard colours:

- white (333) RAL 9016 satin
- white (301) RAL 9010 satin
- sandblast grey metallic 001

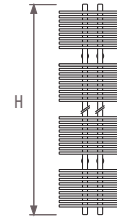

Taboe Sani_double		<i>code</i>	<i>height</i>	<i>length</i>	<i>colour</i>	<i>conn.</i>
		ORDERING CODE: TSDW.	121	050.	XXX	/18

H	L 050	
121	75/65/20 90/70/20	800 1018

Standard delivery

- central connection 18 underneath
- wall fixing set
- chrome-plated air vent and drain cock

Standard colours:

- white (333) RAL 9016 satin
- white (301) RAL 9010 satin
- sandblast grey metallic 001

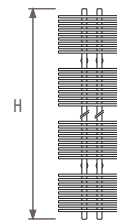

Taboe Sani_single brushed stainless steel		<i>code</i>	<i>height</i>	<i>length</i>	<i>colour</i>	<i>conn.</i>	<i>type</i>
		ORDERING CODE: TSSW.	121	050.	011	/18	/SP

H	L 050	
121	75/65/20 90/70/20	459 581

Standard delivery

- brushed stainless steel
- central connection 18 underneath
- wall fixing set
- chrome-plated air vent and drain cock

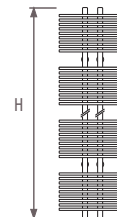

Taboe Sani_double brushed stainless steel		<i>code</i>	<i>height</i>	<i>length</i>	<i>colour</i>	<i>conn.</i>	<i>type</i>
		ORDERING CODE: TSDW.	121	050.	011	/18	/SP

H	L 050	
121	75/65/20 90/70/20	664 847

Standard delivery

- brushed stainless steel
- central connection 18 underneath
- wall fixing set
- chrome-plated air vent and drain cock

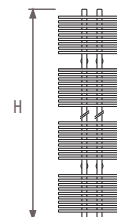

Output measured in accordance with EN442, at a water temperature of 75/65 and a room temperature of 20°C ($\Delta T=50$).

Options

Electro heating

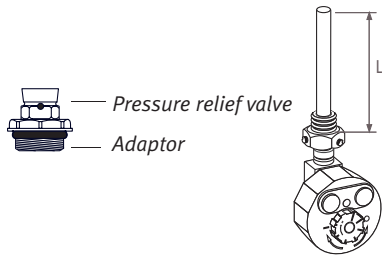

CODE	H	type radiator	WATTS	L
9096.12	121	single	900	51.5
9096.13	121	double	1200	66.0
9096.13	182	single	1200	66.0
9096.14	182	double	1500	82.0

T-piece for mixed application

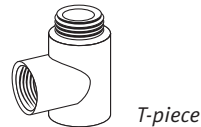

CODE	colour
TPCE.004.009	chrome
TPCE.004.XXX	201 up to 233
	301 up to 333
<i>fill in colour code</i>	

Insert pipe for top end connection

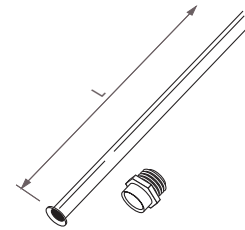

Will be delivered without surcharge if the top end connection code is indicated 45 or 54 instead of 18.

CODE	H radiator	L
9097.1100	121	110
9097.1660	182	166

Electro heating element with infra-red operation

Only for Taboe Sani Single

- Finish: white ABS
- Transmission range: ± 6 m in all directions
- Receiver has to be placed at the back of the radiator.
- Insulation Class 1

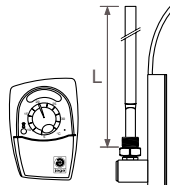

CODE	WATTS	L
9096.510	600	47
9096.520	900	68

Connection electric element

- Fit the electric heating element vertically in the socket 1 or 8. The pressure release valve which is included should be fitted into socket 4 or 5, (3 bar).
- Do not switch the radiator on before filling it completely with water.
- Top up with water after the first total heating up of the radiator.

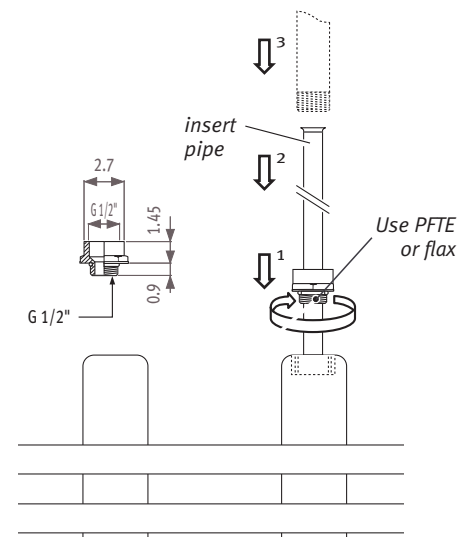

For more information see Technical info.

Taboe Sani

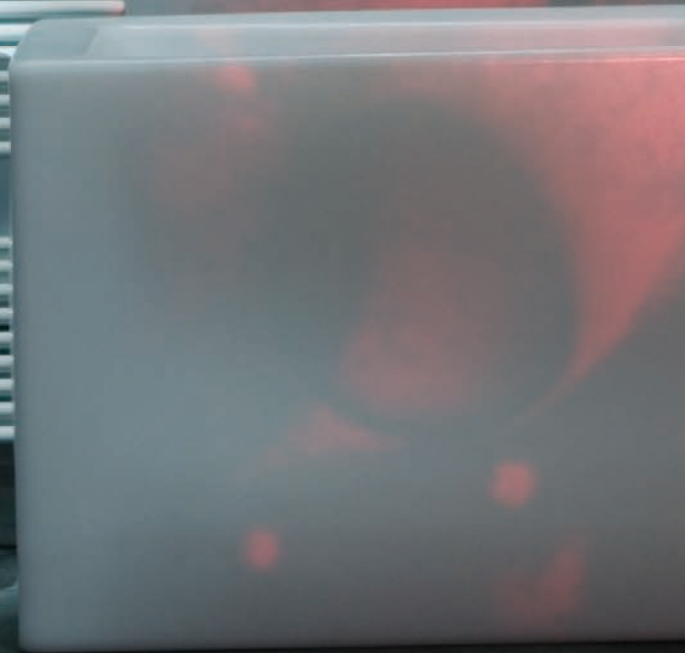
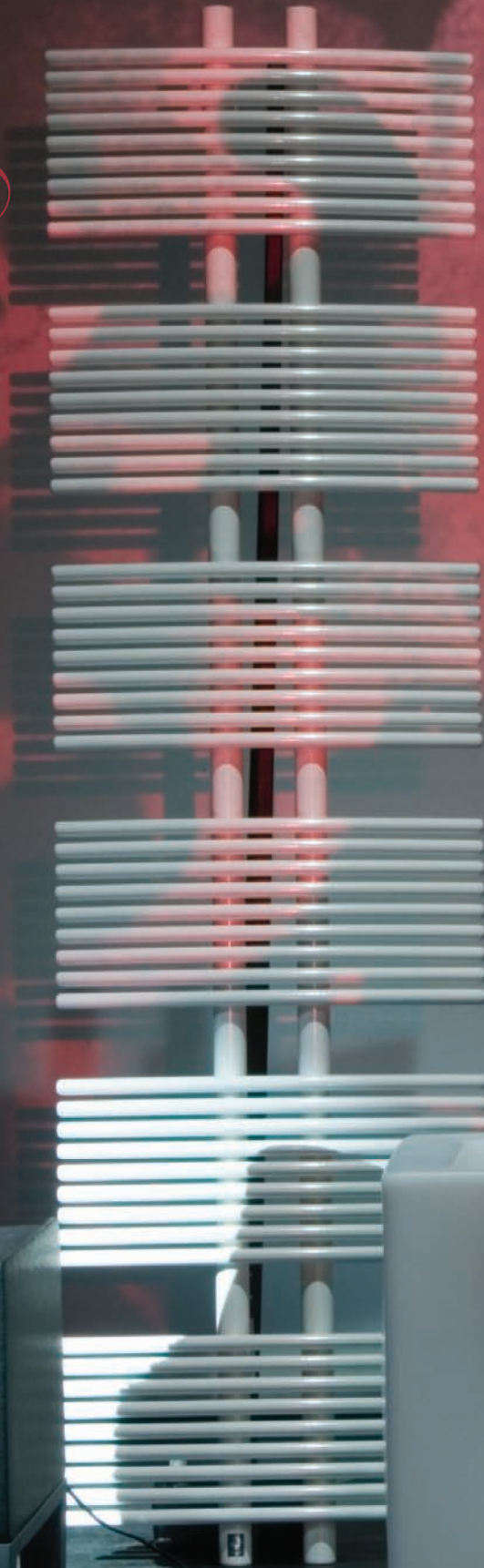

1

2

- 1. Taboe
- 2. Taboe Freestanding

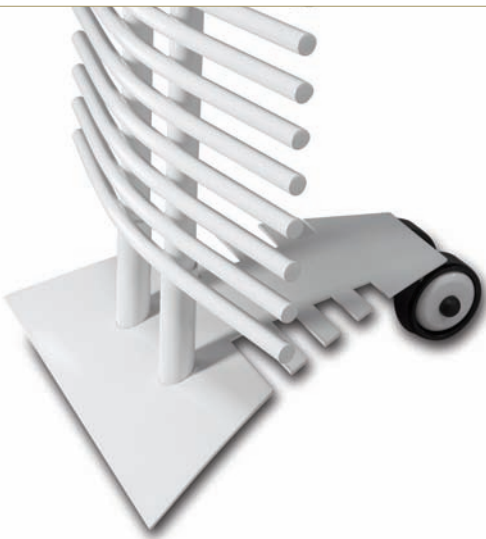

Taboe



Outputs

Taboe wall mounted model_C.H.

code height length colour conn.
ORDERING CODE: TABW. 125 044. XXX /18

H	L 044	
125	75/65/20 90/70/20	432 546
180	75/65/20 90/70/20	629 792

Standard delivery

- 2 wall fixing brackets in the same colour as the radiator
- invisible inside sockets 1/2" at the bottom end of the collector tubes
- air venting via the round balls at the top end of the collector tubes

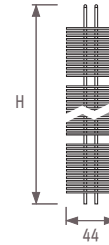

Taboe wall mounted model_EL

code height length colour conn.
ORDERING CODE: TABW. 125 044. XXX /EL

H	L 044	
125	WATTS	600
180	WATTS	900

Standard delivery

- Supplied completely fitted and filled, including electric heating element with a cable of 2.5 m and a plug with an on / off switch
- 2 wall fixing brackets in the same colour as the radiator

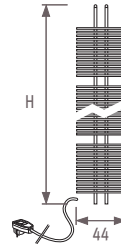

Taboe wall mounted model_MX

code height length colour conn.
ORDERING CODE: TABW. 125 044. XXX /MX

H	L 044	
125	WATTS	600
180	WATTS	900

Standard delivery

- 2 wall fixing brackets in the same colour as the radiator
- invisible inside sockets 1/2" at the bottom end of the collector tubes
- electric element with thermostat Class I Length wire: 1.2 m
- T-piece in the same colour as the radiator
- air venting via the round balls at the top end of the collector tubes

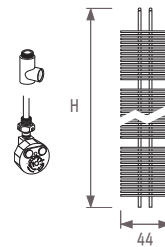

Taboe Freestanding_EL

code height length colour conn.
ORDERING CODE: TABF. 125 044. XXX /EL

H	L 044	
125	WATTS	600
180	WATTS	900

Standard delivery

- Supplied completely fitted and filled, inclusive electric heating element with a cable of 2.5 m and a plug with an on / off switch
- foot in the same colour as the radiator

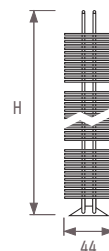

Output measured in accordance with EN442, at a water temperature of 75/65 and a room temperature of 20°C ($\Delta T=50$).